

FRAMELESS GLASS SOLUTIONS - FIXED / INLINE GLASS

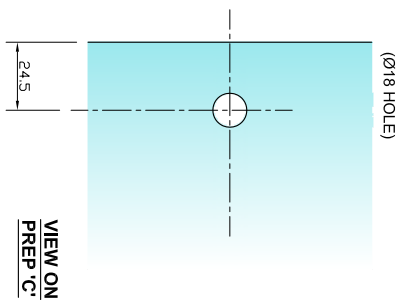

VERTICAL SECTION THROUGH GLASS

(SCALE 1:5 (A4))

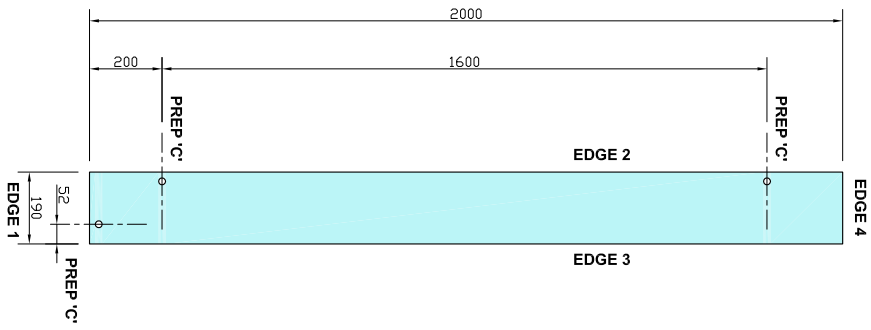
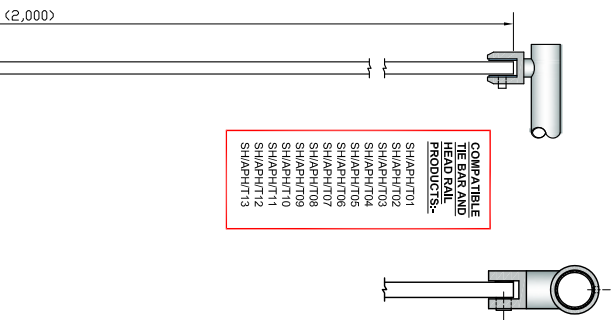

COMPATIBLE TIE BAR AND HEAD RAIL PRODUCTS:-
 SHAPRH01
 SHAPRH02
 SHAPRH03
 SHAPRH04
 SHAPRH05
 SHAPRH06
 SHAPRH07
 SHAPRH08
 SHAPRH09
 SHAPRH10
 SHAPRH11
 SHAPRH12
 SHAPRH13

GLASS TO FLOOR FITTING OPTIONS:-
 SHAPRH01
 SHAPRH02

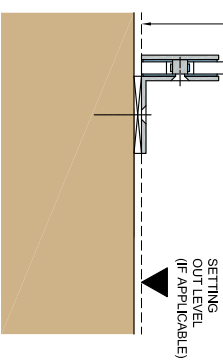

EDGE 2 - EXAMPLE OPTIONS

(SCALE 1:5 (A4))

90 DEGREE GLASS FITTING OPTIONS:-
 SHAPRH02
 SHAPRH02

CORNER / SIDE GLASS REQUIRED FOR STEPPED EDGE

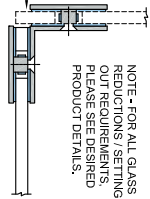

NOTE - FOR ALL GLASS REDUCTIONS / SETTINGS OUT REQUIREMENTS, PLEASE SEE DESIRED PRODUCT DETAILS.

GLASS TO WALL FITTING OPTIONS:-
 SHAPRH01
 SHAPRH02

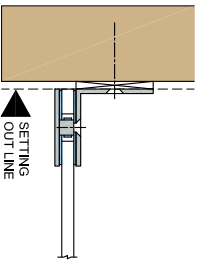

EDGE 3 - EXAMPLE OPTIONS

(SCALE 1:5 (A4))

90 DEGREE ADJACENT DOOR

180 DEGREE ADJACENT DOOR

OPEN ENDED PARTITION GLASS

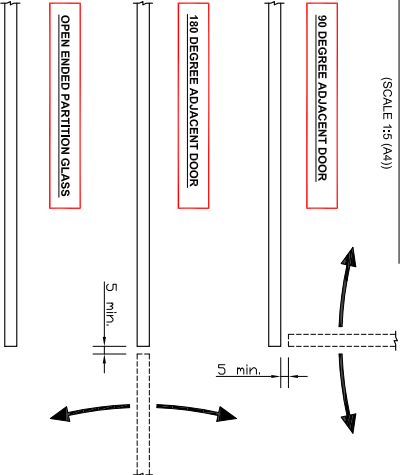

NOTES/SPECIFICATION:

GLASS SUPPLIED IN 8mm CLEAR TOUGHENED GLASS PANES, WITH POLISHED EDGES TO ALL SIDES. ALL TO BS EN12150-1
 GLASS SUPPLIED COMPLETE WITH GLASS PREPERATION DETAILS, TO SUIT OUR STANDARD FITTING COMPONENTS (AS LISTED).

(NOTE - FRAMELESS GLASS SOLUTIONS CAN DESIGN/PROVIDE BESPOKE GLASS PANES IF REQUIRED. TYPICAL VARIATIONS INCLUDE FINISH, SHAPING AND DIMENSIONAL (INCLUDING GLASS THICKNESS))



The Vision Group, 6 Barnes Close, Brandon, Suffolk IP27 0NY
 TEL: +44 (0)1842 816086
 FAX: +44 (0)1842 815515
 WEB: www.spiralhardware.co.uk
 E-MAIL: info@spiralhardware.co.uk

Copyright (c) - April 2008. All Rights Reserved

PRODUCT REF:	FGS/APG/N01
DESCRIPTION:	STANDARD STOCKED GLASS DIMENSIONED ELEVATIONS AND PRODUCT COMPATIBILITY DETAILS
DRAWING REF:	FGS/APG/N01 - 001