



The Vision Group,  
 6 Barnes Close,  
 Brandon, Suffolk  
 IP27 0NY

TEL: +44 (0)1842 816086  
 FAX: +44 (0)1842 815515  
 WEB: www.spiralhardware.co.uk  
 E-MAIL: info@spiralhardware.co.uk

Copyright (c) - April 2008. All Rights Reserved

**NOTES/SPECIFICATION:**

ALL SPIDER GLASS FITTING ARE SUPPLIED IN GRADE 316 CAST STAINLESS STEEL.  
 # = ADDITIONAL FITTING SOLD SEPARATELY.

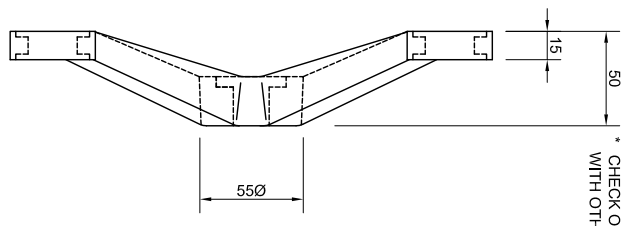

\* CHECK OFFSET COMPATIBILITY WITH OTHER FITTINGS REQUIRED

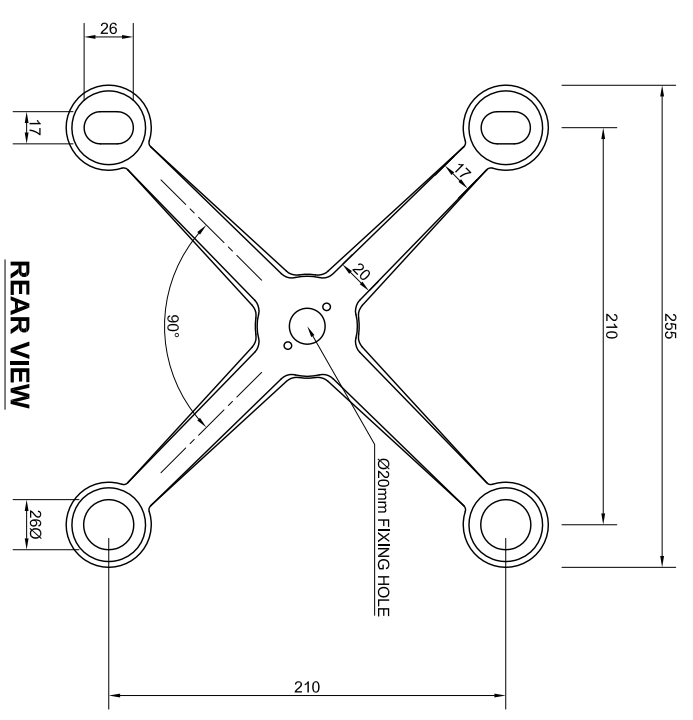

**SIDE VIEW ON FITTING**  
 (SCALE 1:4 (A4))

**REAR VIEW ON FITTING**  
 (SCALE 1:4 (A4))

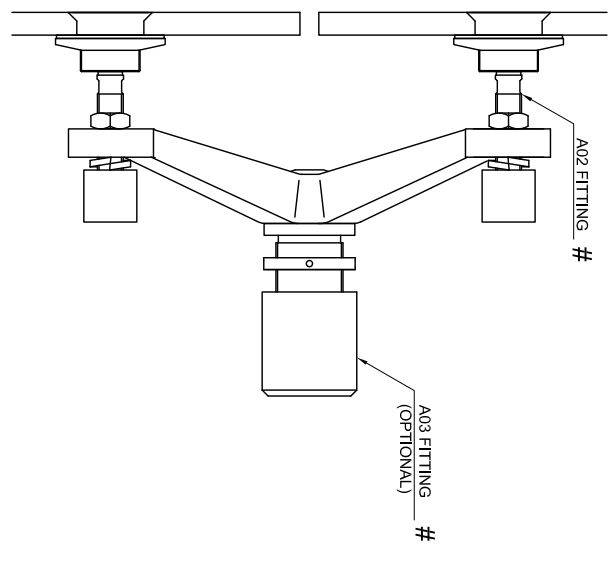
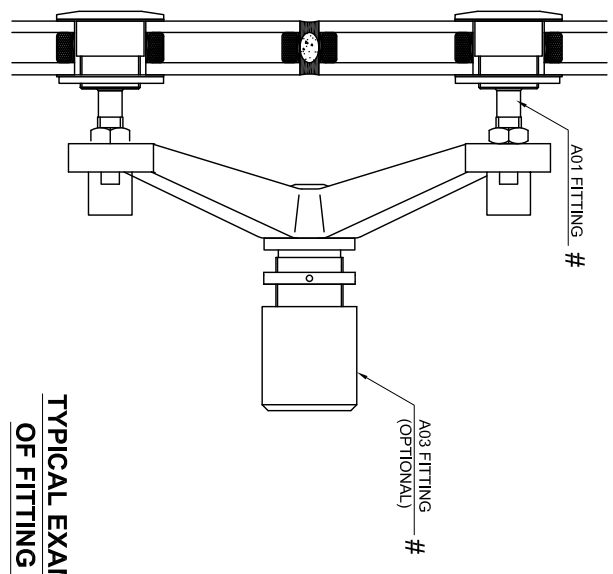

**TYPICAL EXAMPLES OF FITTING USE**  
 (SCALE 1:4 (A4))

<b>PRODUCT REF:</b>	<b>SH/ATS/S01</b>
DESCRIPTION:	DIMENSIONED ELEVATIONS AND SUGGEST APPLICATIONS *
<b>DRAWING REF:</b>	<b>SH/ATS/S01 - 001</b>

# ATLAS SPIDER FITTINGS APPLICATION EXAMPLES

**FACE FIXED  
SPIDER FITTINGS**

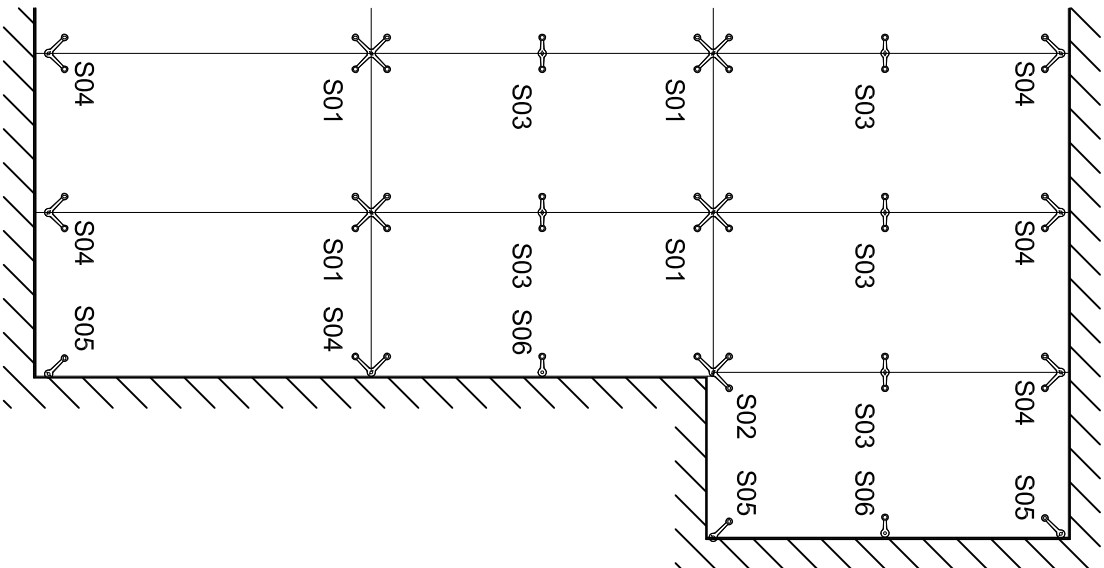

**APERTURE MOUNTED  
SPIDER FITTINGS**

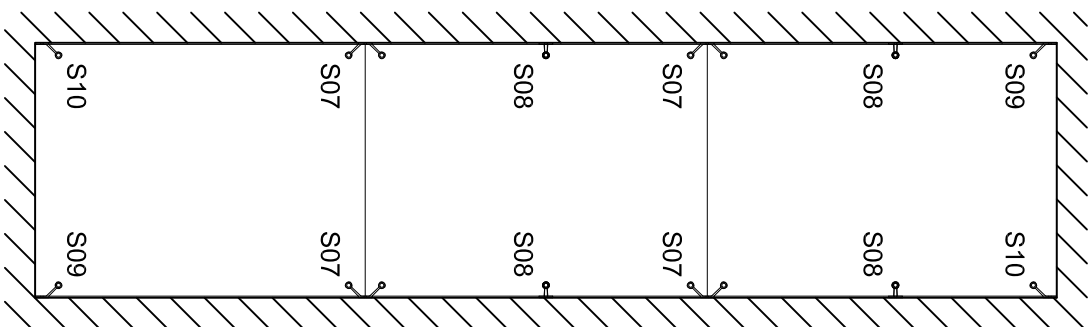

The Vision Group,  
6 Barnes Close,  
Brandon, Suffolk  
IP27 0NY

TEL: +44 (0)1842 816086  
FAX: +44 (0)1842 815515  
WEB: [www.spiralhardware.co.uk](http://www.spiralhardware.co.uk)  
E-MAIL: [info@spiralhardware.co.uk](mailto:info@spiralhardware.co.uk)

Copyright (c) - April 2008. All Rights Reserved

**NOTES/SPECIFICATION:**

**EXAMPLE DETAILS**

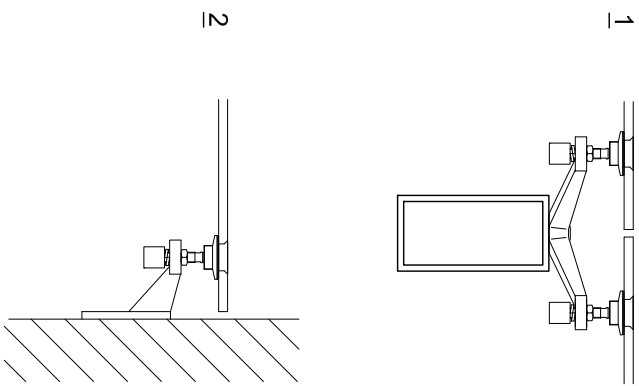

**PRODUCT REF: SH/ATS/**

DESCRIPTION:

ELEVATIONS SHOWING  
FITTINGS TYPES LOCATIONS  
\*

**DRAWING REF: SH/ATS/AE/001**