

**REQUIRED
GLASS PREP**
(SCALE 1:1 (A4))

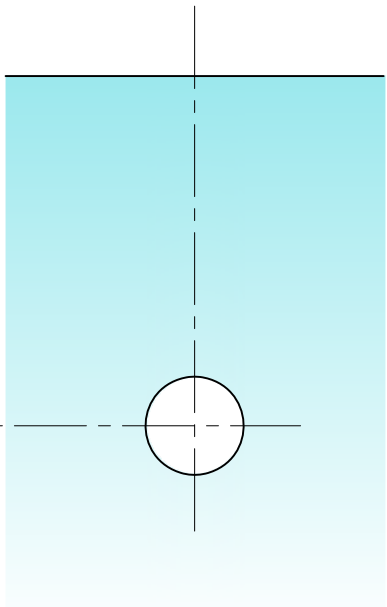

The Vision Group,
6 Barnes Close,
Brandon, Suffolk
IP27 0NY

TEL: **+44 (0)1842 816086**
FAX: **+44 (0)1842 815515**
WEB: **www.spiralhardware.co.uk**
E-MAIL: **info@spiralhardware.co.uk**

Copyright (c) - April 2008. All Rights Reserved

NOTES/SPECIFICATION:

- ALL DOOR KNOB COMPONENTS IN CHROME PLATED BRASS.
- PRODUCT SUITABLE FOR 6 TO 12mm TOUGHENED GLASS PANES.
- DOOR KNOB SUPPLIED COMPLETE WITH:-
- 1) 2 No. x 1.35mm TRANSLUCENT RUBBER GLAZING WASHERS
- 2) 1 No. DIA. 12mm WHITE PLASTIC INSERT TUBE

**SIDE VIEW
ON DOOR KNOB**

(SCALE 1:1 (A4))

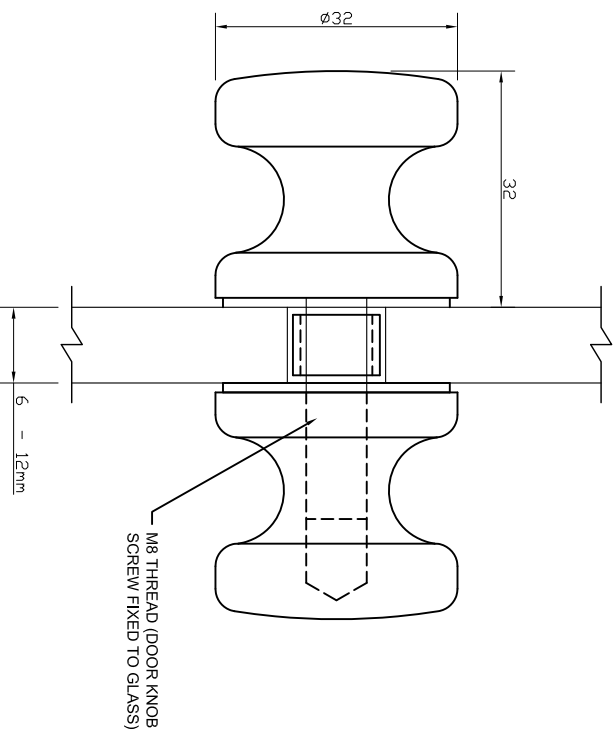

**FRONT VIEW
ON DOOR KNOB**

(SCALE 1:1 (A4))

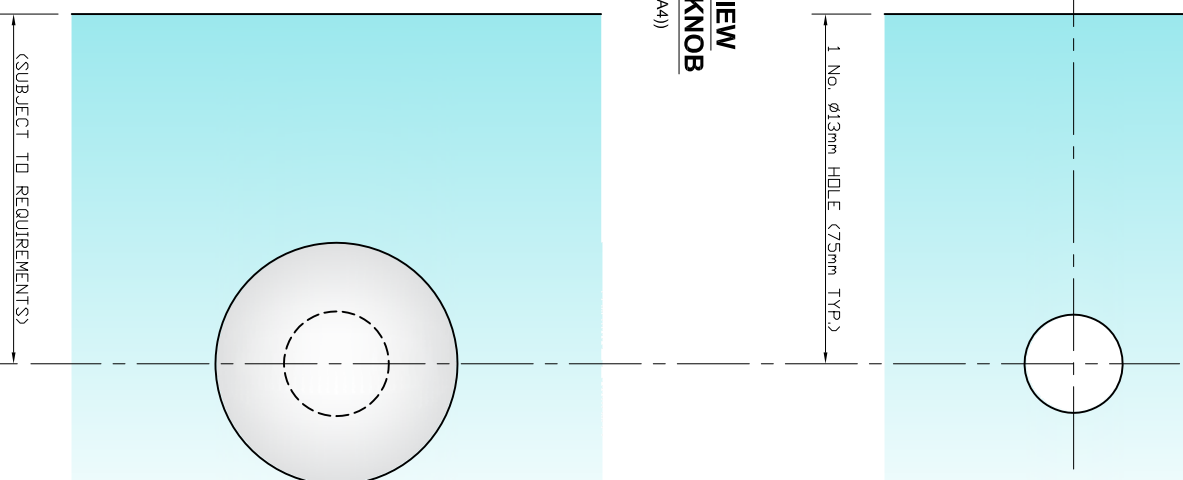

PRODUCT REF:	SH/APH/K08
DESCRIPTION:	DIMENSIONED ELEVATIONS AND GLASS PREP DETAILS
DRAWING REF:	SH/APH/K08 - 001